

















Serial Number	Graphical	Name	Quantlty	Remark
01		anti-splash threshold	1PCS	
02		guide block	1PCS	
03		lower cross tape	1PCS	
04		door seal	2PCS	
05		fixed panel seal	2PCS	
06		sliding door	2PCS	
07		towel bar	2PCS	
08		anti-jumping knob	4PCS	
09		∅6	4PCS	
10		wall mounting	2PCS	
11		ST4*35	4PCS	
12		wall bracket	2PCS	
13		buffer (optional)	4PCS	
14		rail	1PCS	
15		roller	4PCS	
16		Lower water retaining tape	2PCS	
17		∅6	1PCS	
18		ST4*20	1PCS	

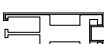

L	A(mm)
1524	1514-1524
1829	1819-1829

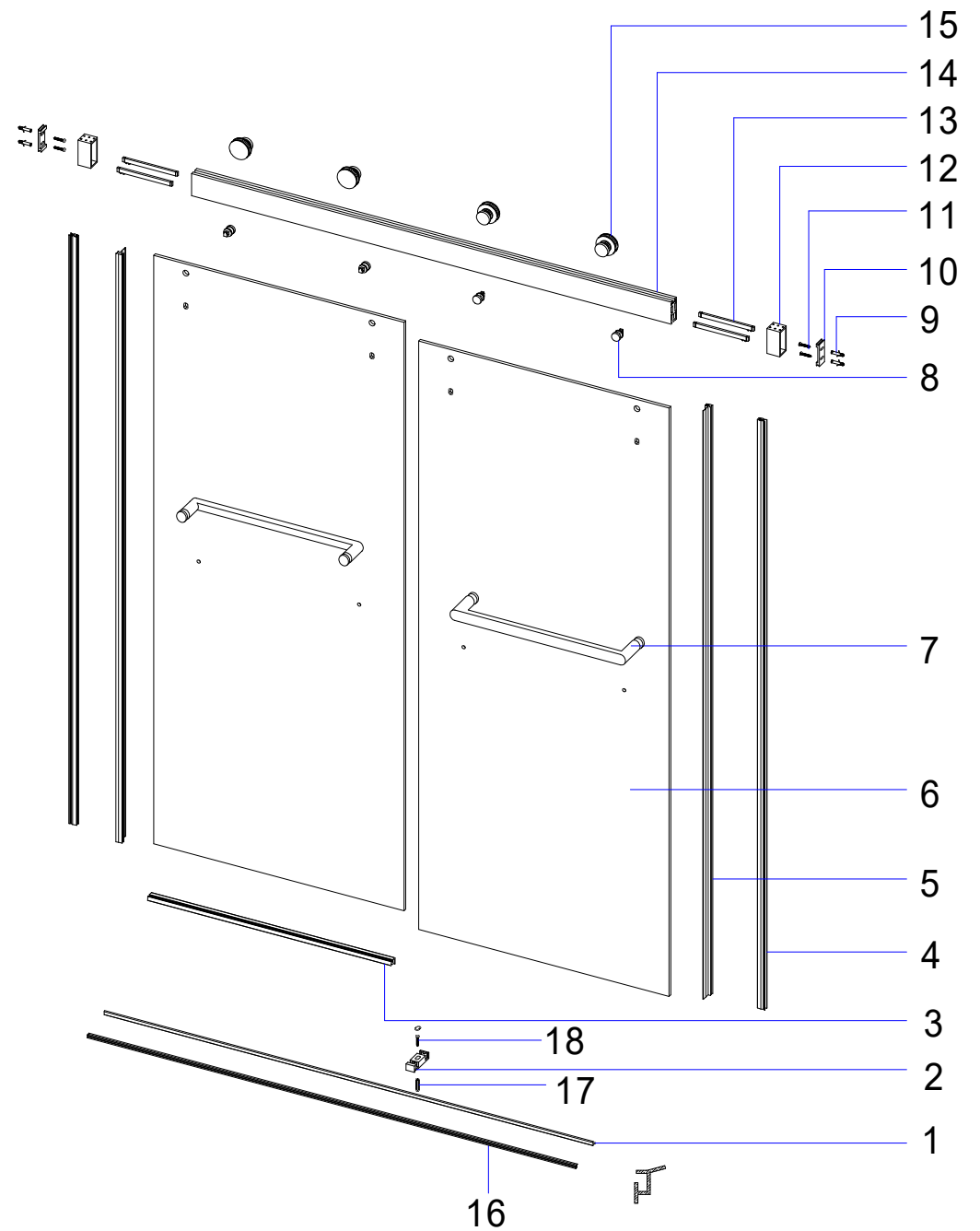
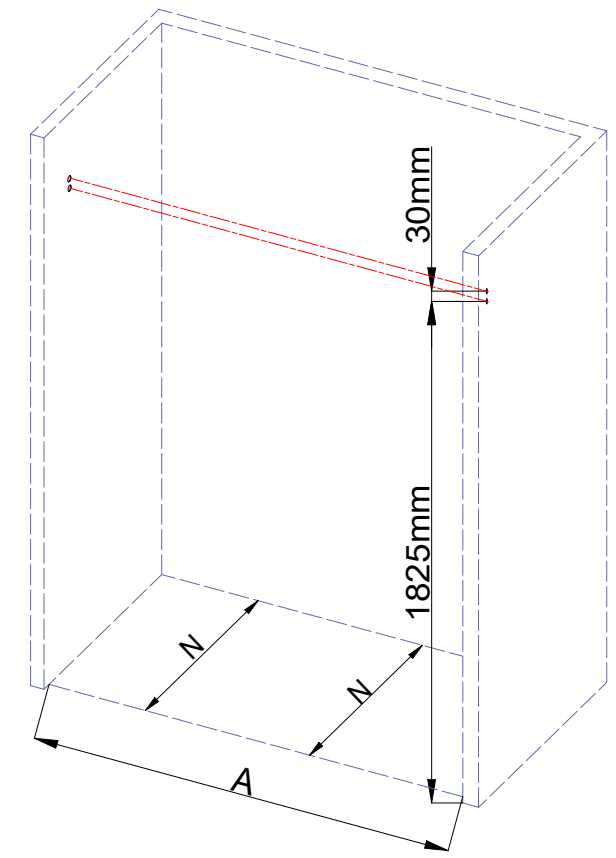
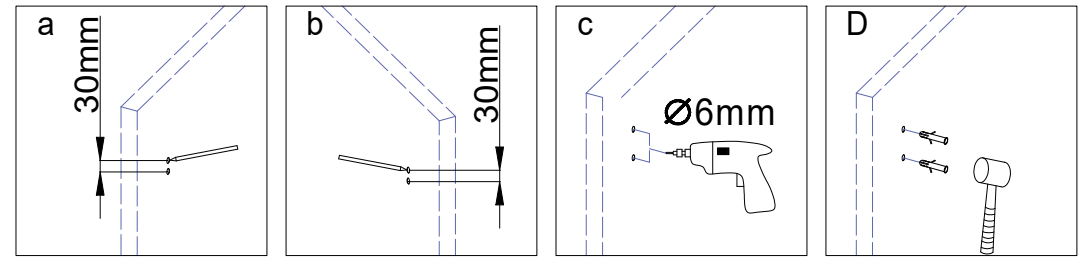
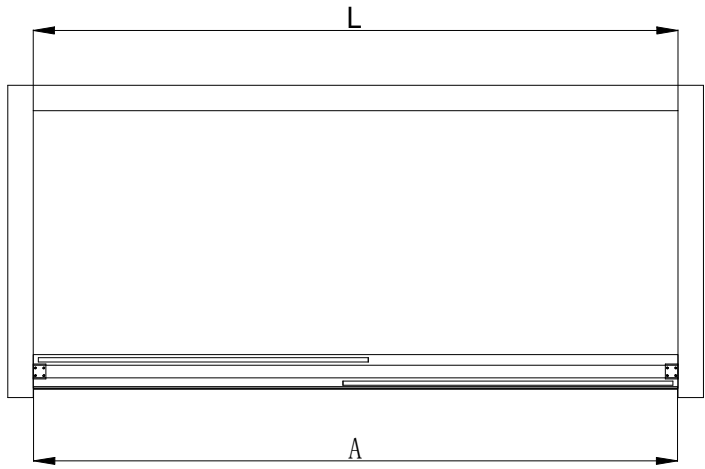

1

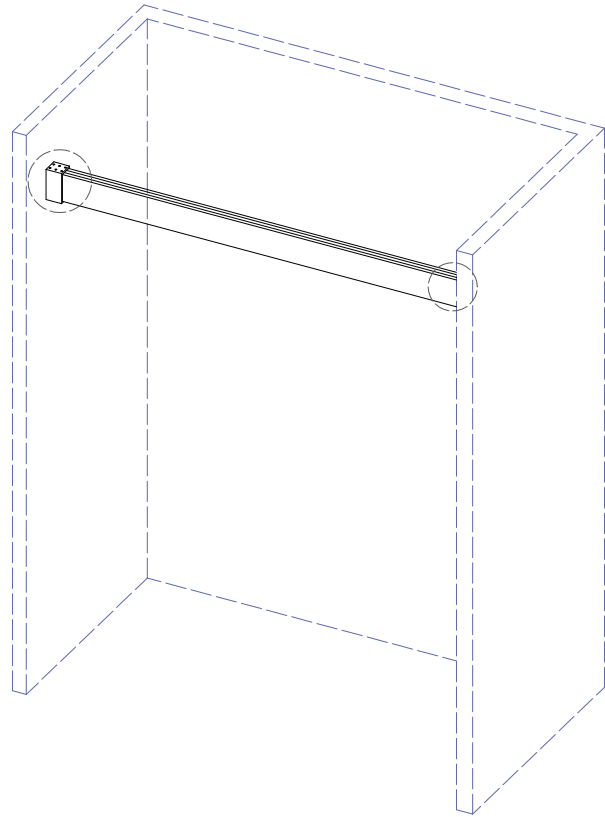
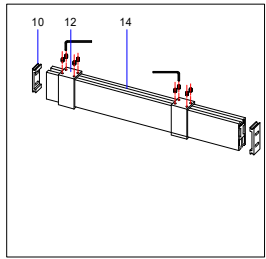
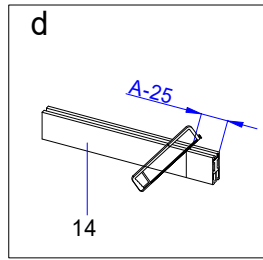
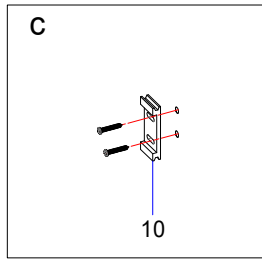
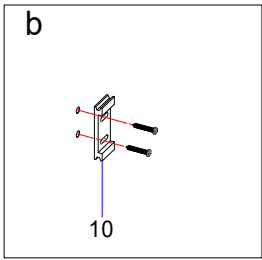
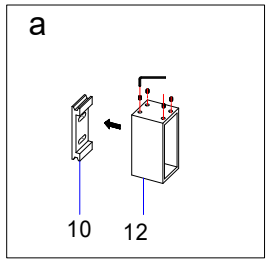

2

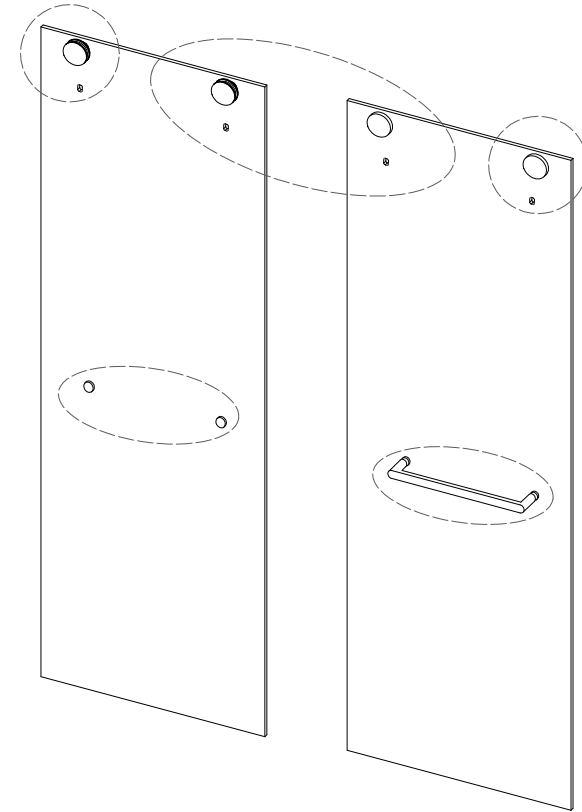
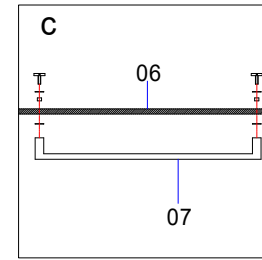
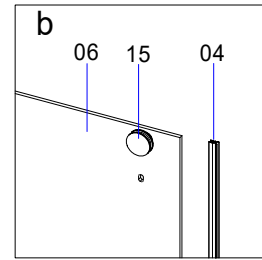
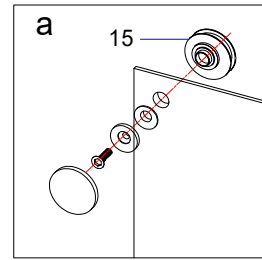

3

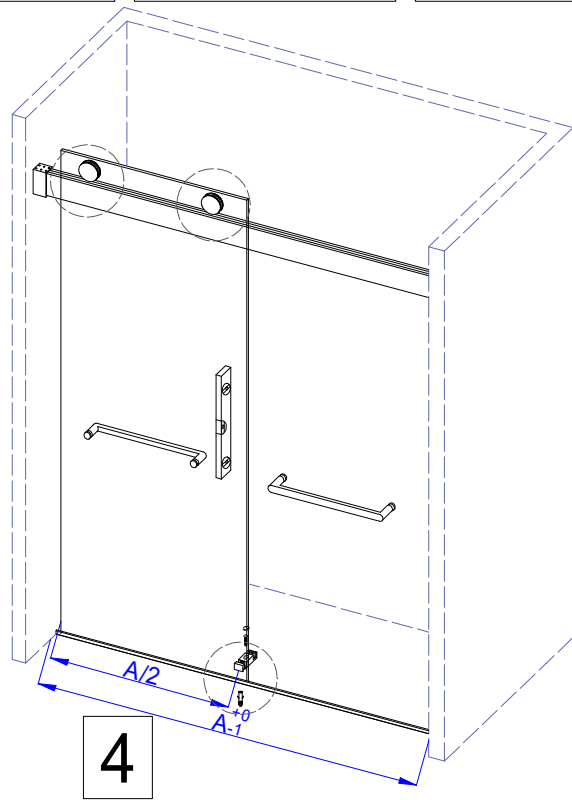
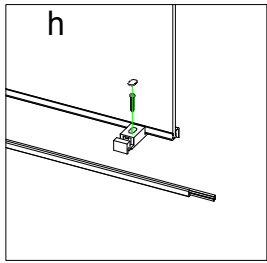
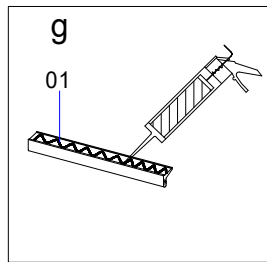
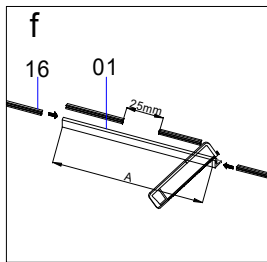
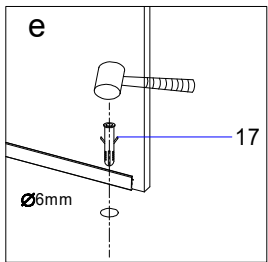
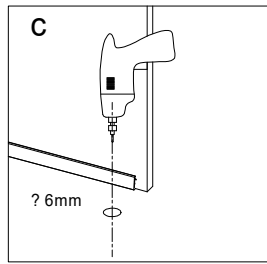
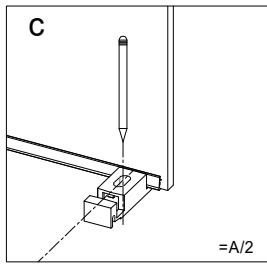
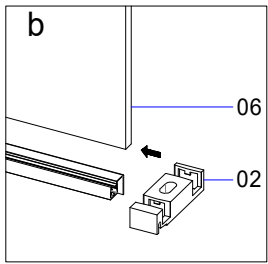
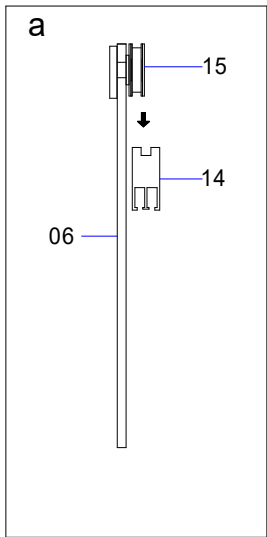

4

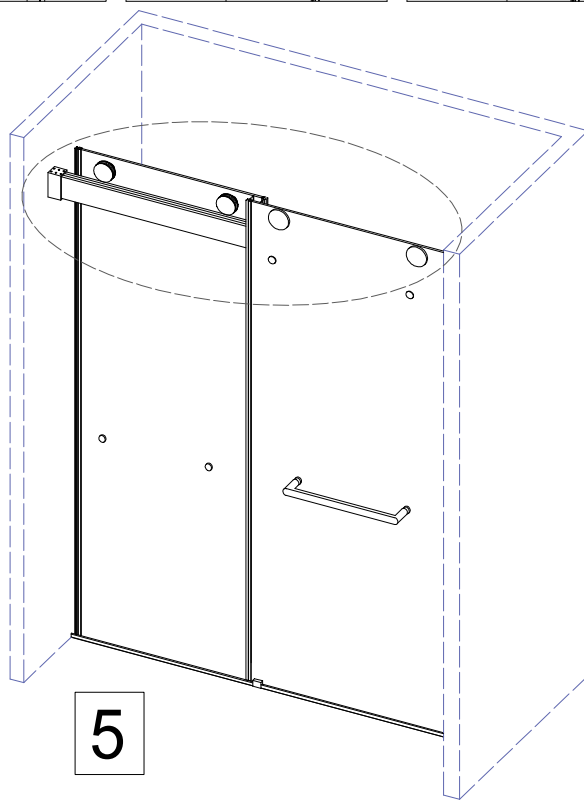
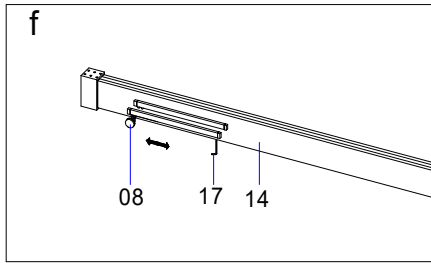
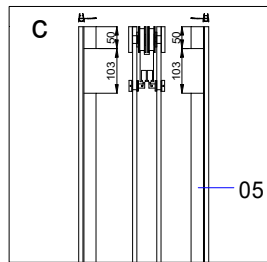
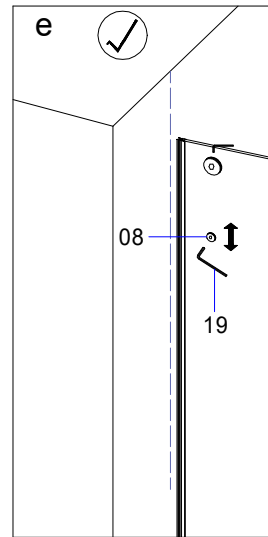
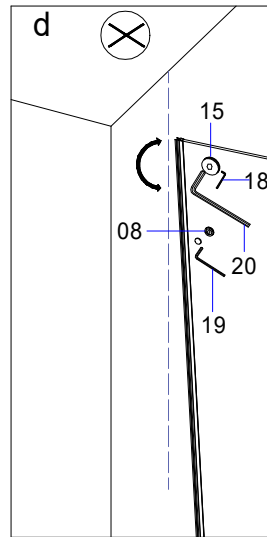
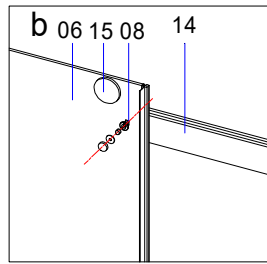
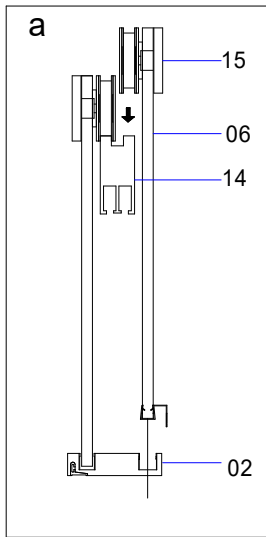

5

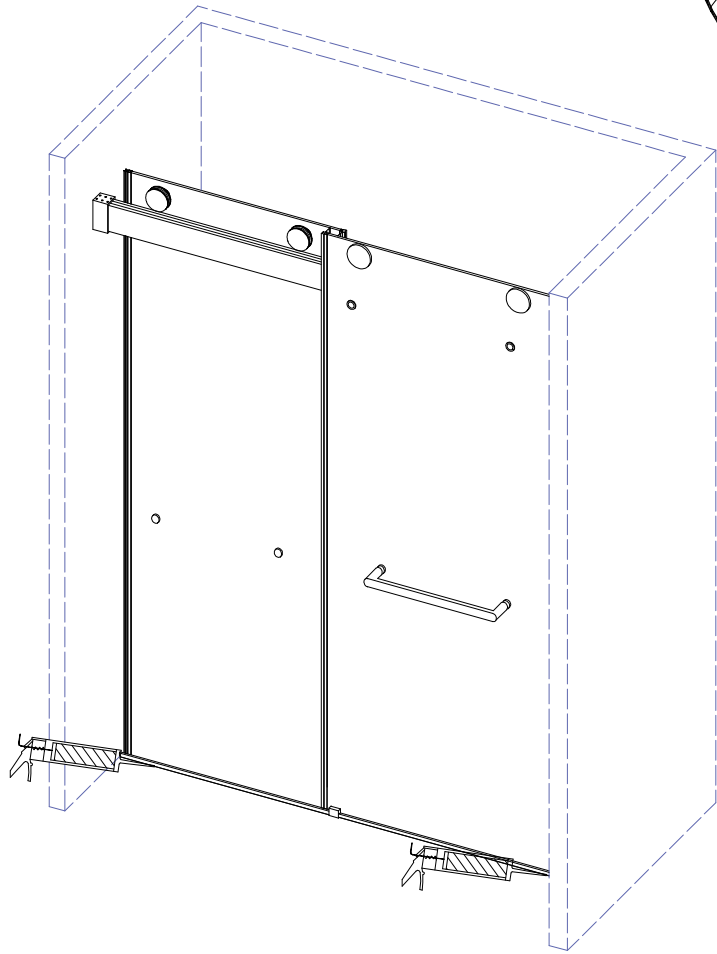

6